

KENWOOD

CD PLAYER

DP-R893

INSTRUCTION MANUAL

KENWOOD CORPORATION



B60-1095-00 (JA) (K, P, M, X, Y) (AP)

96/12 11 10 9 8 7 6 5 4 3 2 1 95/12 11 10 9 8

Introduction

Your choice of this product indicates that you are a devotee to excellence in sound reproduction.

We appreciate your patronage and take pride in the long tradition of quality components that our company represents.

So that you can get the most out of your unit, we suggest that you take the time to read through this manual before you hook up and operate your system. This will acquaint you with operating features and system-connection considerations so that your listening pleasure will be enhanced right from the start. You will notice that in all aspects of planning, engineering, styling, operating convenience and adaptability we have sought to anticipate your needs and desires.

Keep this manual handy for future reference.

For your records

Record the serial number, found on the back of the unit, in the spaces designated on the warranty card, and in the space provided below. Refer to the model and serial numbers whenever you call upon your dealer for information or service on this product.

Model _____ Serial Number _____

Unpacking

Unpack the unit carefully and make sure that all accessories are put aside so they will not be lost.

Examine the unit for any possibility of shipping damage. If your unit is damaged or fails to operate, notify your dealer immediately. If your unit was shipped to you directly, notify the shipping company without delay. Only the consignee (the person or company receiving the unit) can file a claim against the carrier for shipping damage.

We recommend that you retain the original carton and packing materials for use should you transport or ship the unit in the future.

For the U.S.A

CAUTION:

Use of controls or adjustments or performance of procedures other than those specified herein may result in hazardous radiation exposure.

In compliance with Federal Regulations, following are reproductions of labels on, or inside the product relating to laser product safety.

**KENWOOD CORPORATION
SHIONOGI SHIBUYA BUILDING 17-5,
2- CHOME, SHIBUYA, SHIBUYA-KU,
TOKYO, JAPAN**

**KENWOOD CORP. CERTIFIES THIS EQUIPMENT
CONFORMS TO DHHS REGULATIONS NO. 21
CFR 1040.10, CHAPTER I, SUBCHAPTER J.**

Location: Back Panel

The marking of products using lasers (Except for some areas).

**CLASS 1
LASER PRODUCT**

This label is attached to the rear panel and says that the component uses laser beams that have been classified as Class 1. It means that the unit is utilizing laser beams that are of a weaker class.

There is no danger of hazardous radiation outside the unit.

Accessories

Audio cord 1

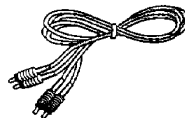

System control cord 1

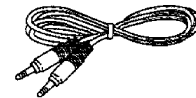



AC plug adaptor 1
(Except for some areas)



For the unit with a European
AC plug in areas other than Europe.

Contents

Caution: Read the pages marked  carefully to ensure safe operation.

Introduction	2	Programmed play (PGM mode)	10
 Before applying power	3	Repeated play	12
 Safety precautions	3	Random play	13
 IMPORTANT SAFEGUARDS	4	Editing	14
System connections	6	Timer operations	16
Controls and indicators	7	Maintenance	17
Manual play (TRACK mode)	8	In case of difficulty	18
		Specifications	19

Before applying power

 **Caution: Read this page carefully to ensure safe operation.**

For the U.S.A. and Canada

Important!

Units shipped to the U.S.A. and Canada are designed for operation on 120 volts AC only.

CAUTION: TO PREVENT ELECTRIC SHOCK DO NOT USE THE AC PLUG WITH AN EXTENSION CORD, RECEPTACLE OR OTHER OUTLET UNLESS THE BLADES CAN BE FULLY INSERTED TO PREVENT BLADE EXPOSURE.

For the United Kingdom

Important!

Units shipped to the U.K. are designed for operation on 240 volts AC only.

The mains plug must be removed from the wall socket prior to any internal examination.

The wires in this mains lead are coloured in accordance with the following code:

Blue Neutral
Brown Live

The wires in this mains lead must be connected to the terminals in the plug as follows:

Wire colour	Plug terminal marking
Blue	N or Black
Brown	L or Red

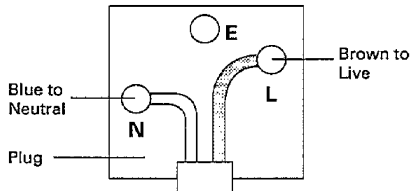

Notes:

1. If a 13-amp plug is used, this must be fitted with a 13-amp fuse.
2. If a 3-pin plug with earthing contact is used, no wire must be connected to the E terminal.

For Australia and Europe

Important!

Units shipped to Australia are designed for operation on 240 V AC only.

Units shipped to Europe are designed for operation on 230 V AC only.

For other countries

Important!

Units shipped to countries other than the above countries are equipped with an AC voltage selector switch on the rear panel. Refer to the following paragraph for the proper setting of this switch.

AC voltage selection

This unit operates on 110 - 120 or 220 - 240 volts AC. The AC voltage selector switch Type A or Type B on the rear panel is set to the voltage that prevails in the area to which the unit is shipped. Before connecting the power cord to your AC outlet, make sure that the setting position of this switch matches your line voltage. If not, it must be set to your voltage in accordance with the following direction.

AC voltage selector switch

Type A

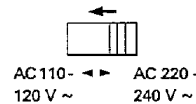

Type B

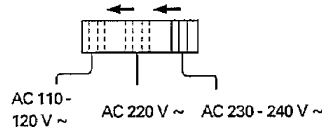





Move switch lever to match your line voltage with a small screwdriver or other pointed tool.

Note:

Our warranty does not cover damage caused by excessive line voltage due to improper setting of the AC voltage selector switch.

Safety precautions

WARNING: TO PREVENT FIRE OR ELECTRIC SHOCK, DO NOT EXPOSE THIS APPLIANCE TO RAIN OR MOISTURE.

 <div style="border: 1px solid black; padding: 5px; text-align: center;"> CAUTION <small>RISK OF ELECTRIC SHOCK DO NOT OPEN</small> </div> 	<p>CAUTION: TO REDUCE THE RISK OF ELECTRIC SHOCK, DO NOT REMOVE COVER (OR BACK). NO USER-SERVICEABLE PARTS INSIDE, REFER SERVICING TO QUALIFIED SERVICE PERSONNEL.</p>
	<p>THE LIGHTNING FLASH WITH ARROWHEAD SYMBOL, WITHIN AN EQUILATERAL TRIANGLE, IS INTENDED TO ALERT THE USER TO THE PRESENCE OF UNINSULATED "DANGEROUS VOLTAGE" WITHIN THE PRODUCT'S ENCLOSURE THAT MAY BE OF SUFFICIENT MAGNITUDE TO CONSTITUTE A RISK OF ELECTRIC SHOCK TO PERSONS.</p>
	<p>THE EXCLAMATION POINT WITHIN AN EQUILATERAL TRIANGLE IS INTENDED TO ALERT THE USER TO THE PRESENCE OF IMPORTANT OPERATING AND MAINTENANCE (SERVICING) INSTRUCTIONS IN THE LITERATURE ACCOMPANYING THE APPLIANCE.</p>

IMPORTANT SAFEGUARDS

 **Caution: Read this page carefully to ensure safe operation.**

Please read all of the safety and operating instructions before operating this unit. For best results, follow all warnings placed on the unit and adhere to the operating and use instructions. These safety and operating instructions should be retained for future reference.

- 1. Power sources** – The unit should be connected to a power supply only of the type described in the operating instructions or as marked on the appliance.
- 2. Power-cord protection** – Power-supply cords should be routed so that they are not likely to be walked on or pinched by items placed upon or against them, pay particular attention to cords at plugs, convenience receptacles, and the point where they exit from the unit.

Never pull or stretch the cord.

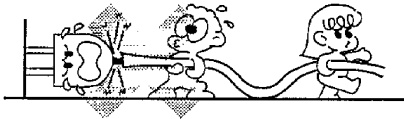

- 3. Grounding or polarization** – The precautions should be taken so that the grounding or polarization means of this unit is not defeated.
- 4. Ventilation** – The unit should be situated so that its location or position does not interfere with its proper ventilation. To maintain good ventilation, do not put records or a table-cloth on the unit. Place the unit at least 10 cm away from the walls. Do not use the unit on a bed, sofa, rug or similar surface that may block the ventilation openings.

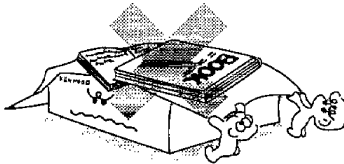

- 5. Water and moisture** – The unit should not be used near water - for example, near a bathtub, washbowl, kitchen sink, laundry tub, in a wet basement, or near a swimming pool, etc.

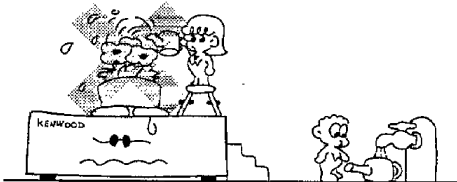

- 6. Temperature** – The unit may not function properly if used at extremely low, or freezing temperatures. The ideal ambient temperature is above +5°C (41°F).

- 7. Heat** – The unit should be situated away from heat sources such as radiators, heat registers, stoves, or other units (including amplifiers) that produce heat.

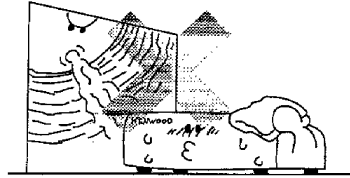

- 8. Electric shock** – Care should be taken so that objects do not fall and liquid is not spilled into the enclosure through openings. If a metal object, such as a hair pin or a needle, comes into contact with the inside of this unit, a dangerous electric shock may result. For families with children, never permit children to put anything, especially metal, inside this unit.

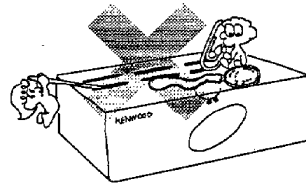

- 9. Enclosure removal** – Never remove the enclosure. If the internal parts are touched accidentally, a serious electric shock might occur.

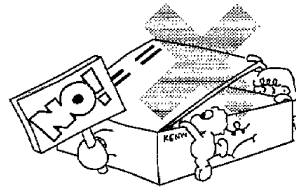

- 10. Magnetic fields** – Keep the unit away from sources of magnetic fields such as TV sets, speaker systems, radios, motorized toys or magnetized objects.

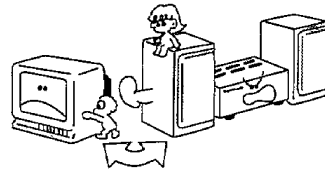

- 11. Cleaning** – Do not use volatile solvents such as alcohol, paint thinner, gasoline, or benzene, etc. to clean the cabinet. Use a clean dry cloth.

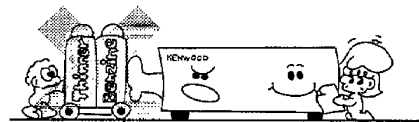

12. Carts and stands – An appliance and cart combination should be moved with care. Quick stops, excessive force, and uneven surfaces may cause the appliance and cart combination to overturn.



13. Nonuse periods – The power cord of the unit should be unplugged from the outlet when left unused for a long period of time.

14. Abnormal smell – If an abnormal smell or smoke is detected, immediately turn the power OFF and pull out the power cord. Contact your dealer or nearest service center.

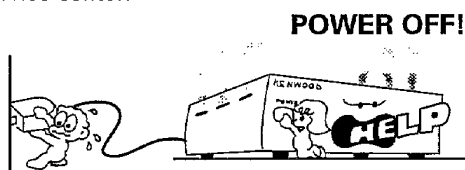

17. Outdoor antenna grounding – If an outside antenna is connected to the receiver, be sure the antenna system is grounded so as to provide some protection against voltage surges and built up static charges. Section 810 of the National Electrical Code, ANSI/NFPA 70, provides information with respect to proper grounding of the mast and supporting structure, grounding of the lead-in wire to an antenna discharge unit, size of grounding conductors, location of antenna-discharge unit, connection to grounding electrodes, and requirements for the grounding electrode. See Figure.

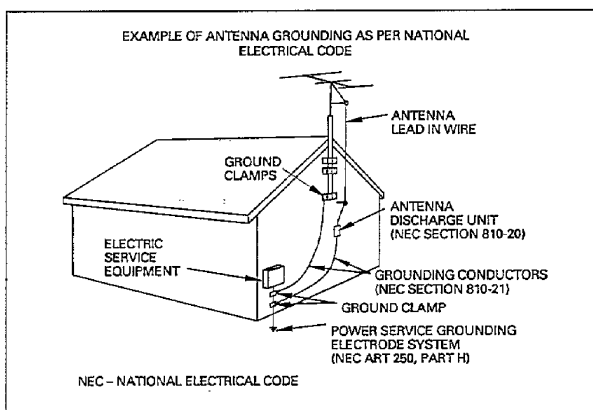

15. Damage requiring service – The unit should be serviced by qualified service personnel when:

- A. The power-supply cord or the plug has been damaged; or
- B. Objects have fallen, or liquid has been spilled into the unit; or
- C. The unit has been exposed to rain; or
- D. The unit does not appear to operate normally or exhibits a marked change in performance; or
- E. The unit has been dropped, or the enclosure damaged.

16. Servicing – The user should not attempt to service the unit beyond that described in the operating instructions. All other servicing should be referred to qualified service personnel.

18. Power lines – An outdoor antenna should be located away from power lines.

19. AC outlets – Do not connect other audio equipment with a power consumption larger than that specified to the AC outlet on the rear panel. Never connect other electrical units, such as an iron or toaster, to it to prevent fire or electric shock.

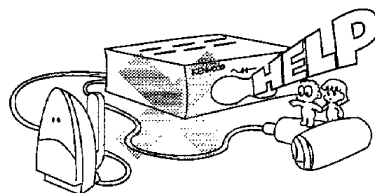

Notes:

1. Item 3 is not required except for grounded or polarized equipment.
2. Item 17 and 18 are not required except for units provided with antenna terminals.
3. Item 17 complies with UL in the U.S.A.

System connections

Make connection as shown below. When connecting the related system components, refer also to the instruction manuals of the related components.

Do not plug in the power lead until all connections are completed.

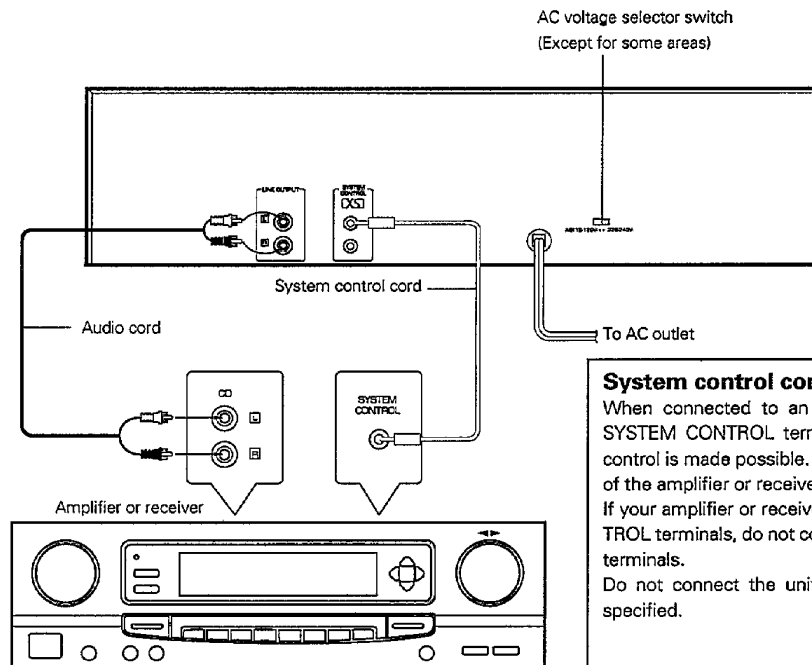

System control connection

When connected to an amplifier or receiver having KENWOOD SYSTEM CONTROL terminals, system operation such as remote control is made possible. For details, refer to the instruction manual of the amplifier or receiver.

If your amplifier or receiver is not equipped with the SYSTEM CONTROL terminals, do not connect anything to any SYSTEM CONTROL terminals.

Do not connect the unit in any system configuration other than specified.

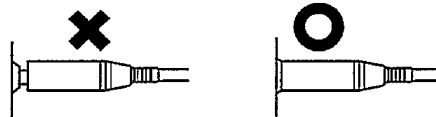

- Be sure to insert the system control cord plugs fully into the SYSTEM CONTROL terminals.
- If the system control cord and audio cords are not connected properly, the automatic system governing remote control and system functions will not operate.

Notes:

1. Connect all cords firmly. If connections are loose there could be loss of sound or noise produced.
2. When plugging and unplugging connection cords, be sure to first remove the power cord from the AC outlet.
Plugging/unplugging connection cords without removal of the power cord can cause malfunctions or damage to the unit.

Disc handling precautions

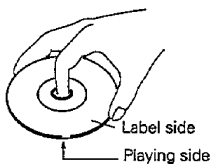

Handling

Hold compact discs so that you do not touch the playing surface.



Do not attach paper or tape to either the playing side or the label side of compact discs.

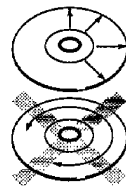

Cleaning

If fingerprints or foreign matter become attached to the disc, lightly wipe the disc with a soft cotton cloth (or similar) from the center of the disc outwards in a radial manner.

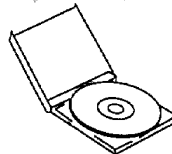

Storage

When a disc is not to be played for a long period of time, remove it from the CD player and store it in its case.

Controls and indicators

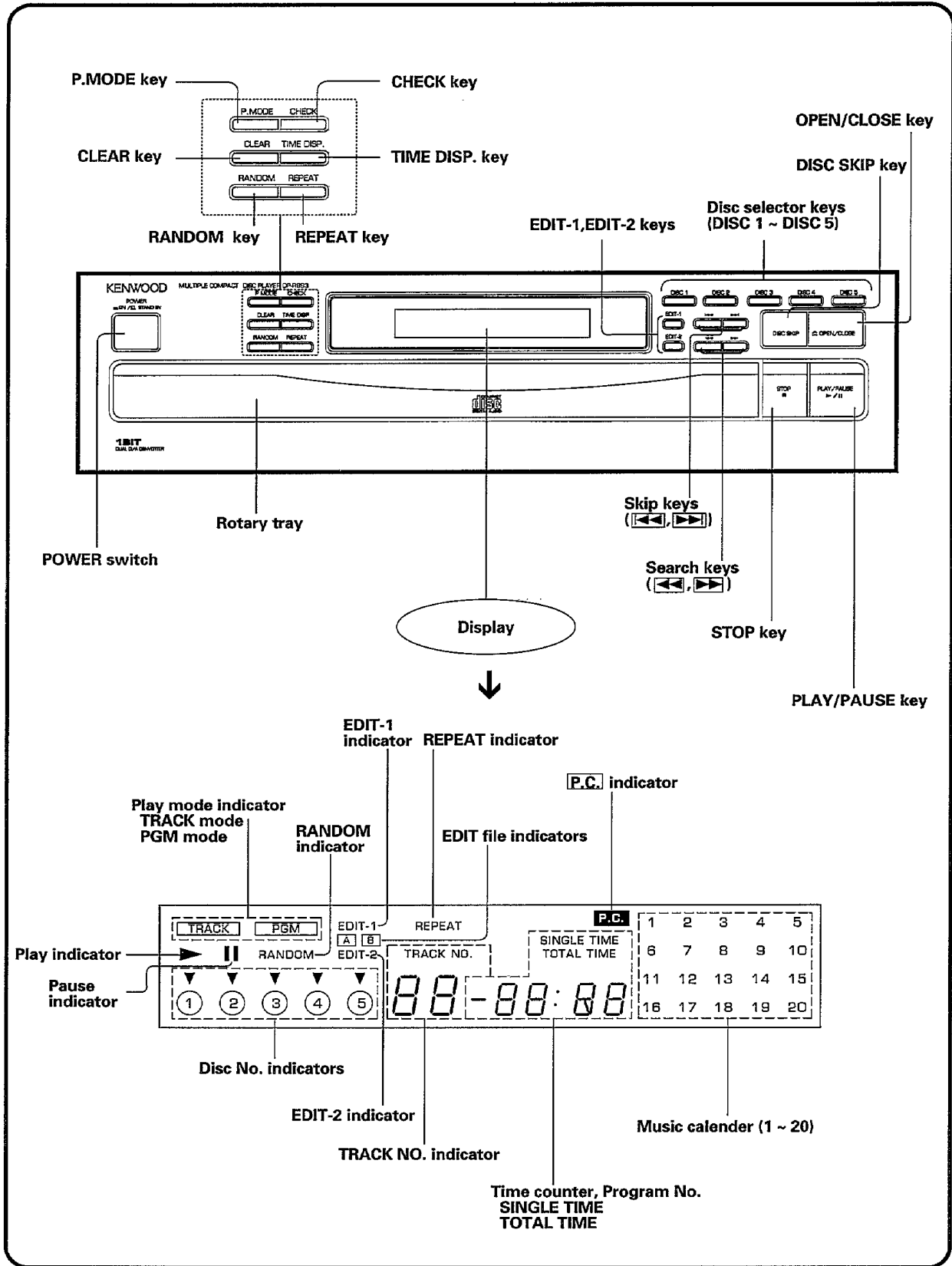

Manual play (TRACK mode)

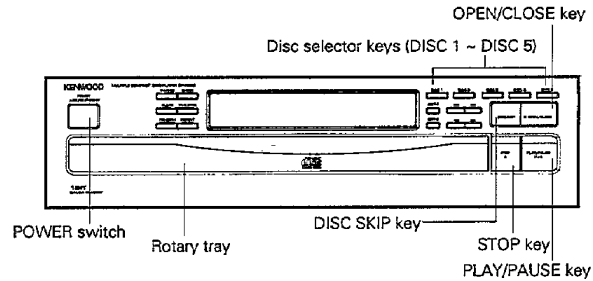

■ Playing a CD from the beginning

1 Press the POWER switch to ON.

2 Load a CD.

- ① Open the disc tray. → ② Place a disc on the tray.

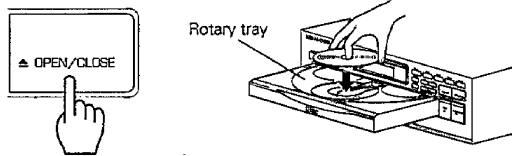

- When inserting two or more discs, use the **DISC SKIP** key to rotate the tray. Up to five discs may be inserted.
- When inserting a disc while the tray rotates, a malfunction might occur. Insert the disc when the tray does not rotate.

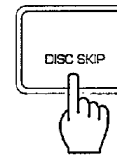

Hold the disc taking care not to touch the side to be played.

3 Close the tray.

- After the tray is closed completely, perform next step.

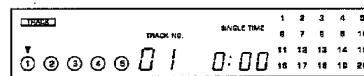
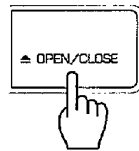

The disc number of the inserted disc will light up.

4 Start playback.

Select the disc.

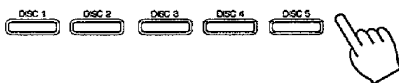

Display showing number of disc being played (▼)

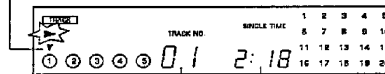

Track No. being played

Elapsed time from the beginning of track being played

- Play will commence from the disc selected. When two or more discs are inserted, the discs will be played in ascending order from disc 1.
- When the **PLAY/PAUSE** key is pressed without selecting a disc, play will automatically commence in order of ascending disc number from the disc last inserted.

To pause CD play

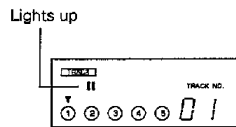

Lights up

To resume playback, press the key again.

To stop CD play



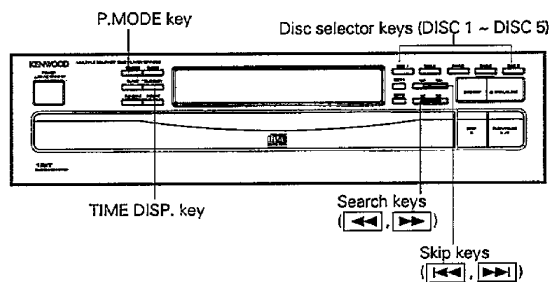

■ Listening from the desired track

1 Ensure that the CD player is in the TRACK mode.

- If the [PGM] indicator is lighted, press the [P.MODE] key.

2 Select the desired disc.



3 Select the desired track.

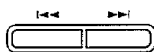

Continue pressing until the desired track No. appears.

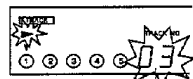

TRACK No.

- The selected track number and play indicator will light up, and the track will start to play.
- When the [◀▶] key is pressed once during play, the track starts again from the beginning.

To fast forward and backward

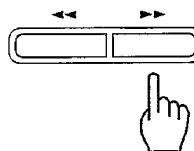

- The track will start to play from where you release the key.

Tracks can be selected directly using the numeric keys on a KENWOOD amplifier/receiver remote control by connecting the CD player to the amplifier/receiver using a system control cord.

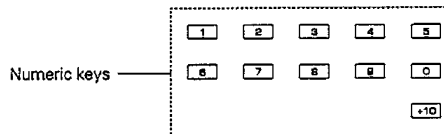

For more details, please refer to your amplifier or receiver instruction manual.

TIME DISP. key

Press the [TIME DISP.] key when you want to check the elapsed time and remaining time of the track being played. Every time the [TIME DISP.] key is pressed, the displayed time changes as shown below.

The time information display may not appear when playing a CD containing 21 or more tracks. In such a case, the display will show "----". During random play or programmed play, display will show SINGLE TIME only.

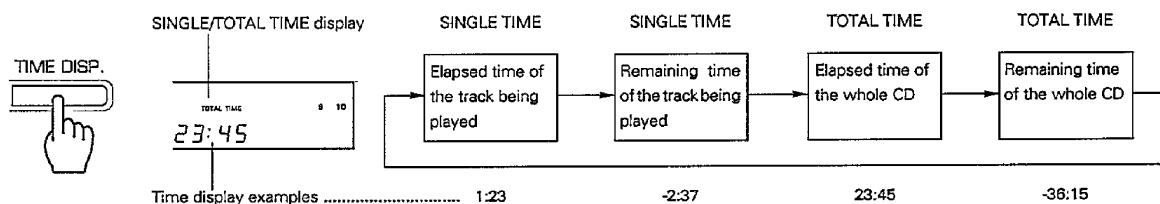

Programmed play (PGM mode)

The program mode allows you to play desired tracks in the order you want to hear them. A maximum of 20 selections can be entered in memory.

■ Playing desired tracks in desired order

1 Press the STOP key.

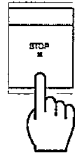

2 Enter the PGM mode.

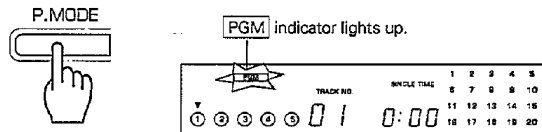

3 Program desired tracks in desired order.

Example: Select track 5 on DISC 4.

① Select the disc.

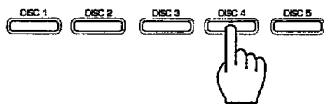

② Select the track number.

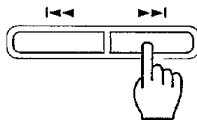

③ Press the P.MODE key.

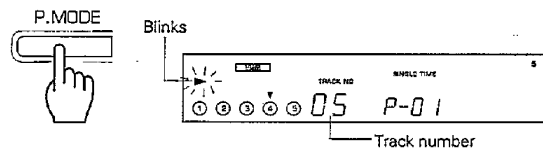

- When selecting tracks using the numeric keys on the remote control of the amplifier/receiver, the **P.MODE** key does not have to be pressed after the tracks have been selected.
- By repeating steps ① ② ③, up to twenty tracks may be selected.
- If you made a mistake, press the **CLEAR** key and select the correct track.
- By pressing the **P.MODE** key without selecting track numbers, all the tracks on the disc selected in step ① will be programmed.

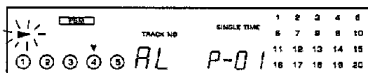

4 Start playback.

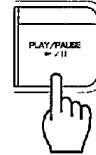

- If one of the skip keys (**▶▶** or **◀◀**) is pressed during programmed playback, the track being played is skipped in the forward or reverse direction.

To check the programmed order

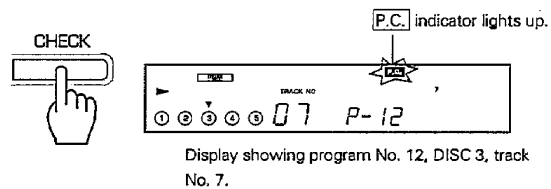

- Every time the **CHECK** key is pressed, the track No. and the order it was programmed (P-No.) are displayed in the order of programming.
- The previous display will resume in a few seconds.

To resume normal playback

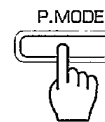

- The playback in the order of the track Nos. on CD will start after the track being played.

To stop programmed playback



■ To add a track to the program

1 Press the STOP key.

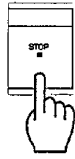

2 Select the track No. to be added.

① Select the disc.

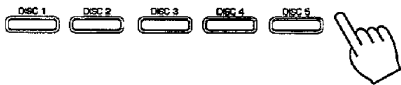

② Select the track number.

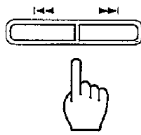

③ Press the P.MODE key.

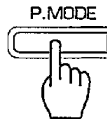

■ To clear tracks from the program

Clearing from the last track

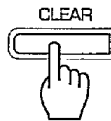

- Every time the key is pressed, tracks are cleared from the last track in order.
- The track being played cannot be cleared.

Clearing the whole of program

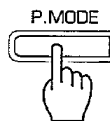

- Selected tracks will be completely cleared just by pressing the **OPEN/CLOSE** key.

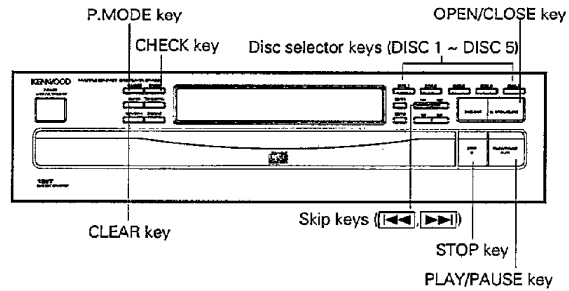

■ To change a track in the program

1 Press the STOP key.

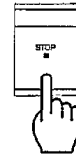

2 Press the CHECK key.

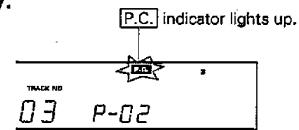
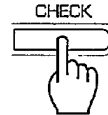

Press until the P.No. to be changed is displayed.

3 Select the track No. to replace the previous one.

① Select the disc.

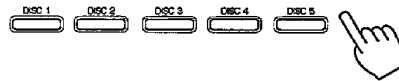

② Select the track number.

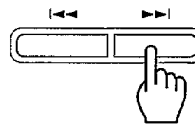

③ Press the P.MODE key.

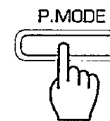







Auto-Space function

In the program mode, a space of about 4 seconds is inserted automatically between the programmed tracks. This function is provided to facilitate the DPSS function of the cassette deck. However, such a space may also be inserted in case the sound of two tracks are continued, for example with some classic music and live recordings.

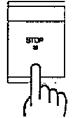

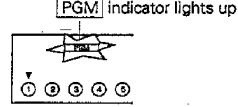

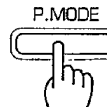
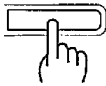
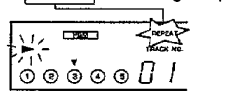
Repeated play

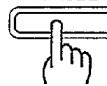
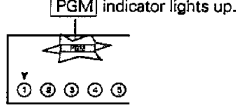

■ Repeated playback

One-disc repeat

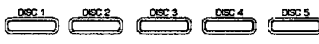

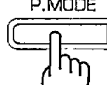
- 1 Press the **STOP** key. 
- 2 Enter the **PGM** mode.   P.MODE indicator lights up.
- 3 Select the desired disc.   Press the **P.MODE** key once again.
- 4 Press the **REPEAT** key.   REPEAT indicator lights up.
- 5 Start playback. 

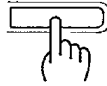
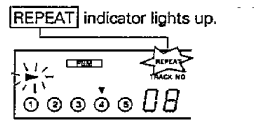
Repeated playback of programmed tracks

- 1 Press the **STOP** key. 
- 2 Enter the **PGM** mode.   P.MODE indicator lights up.
- 3 Select the desired track(s).
 - 1 Select the disc.  
 - 2 Select the track number.  
 - 3 Press the **P.MODE** key.  P.MODE
 - When selecting tracks using the numeric keys on the remote control of the amplifier/receiver, the **P.MODE** key does not have to be pressed after the tracks have been selected.
 - All of the selected tracks will be played repeatedly.
 - If only one track is selected, that track will be played repeatedly.

- 4 Press the **REPEAT** key.   REPEAT indicator lights up.
- 5 Start playback. 

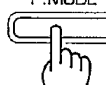
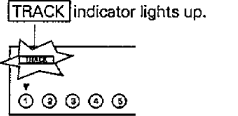
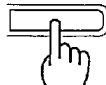
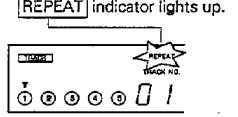
All-disc repeat

- 1 Enter the **TRACK** mode.   TRACK indicator lights up.
- 2 Press the **REPEAT** key.   REPEAT indicator lights up.
- 3 Start playback. 
 - All tracks on all discs in the tray will be played repeatedly.

To stop repeat play

Press the **REPEAT** key again.

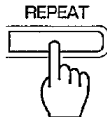

Random play

The random play function chooses tracks at random (non-selected), and in differing order. It lets you enjoy hours of tireless track listening.

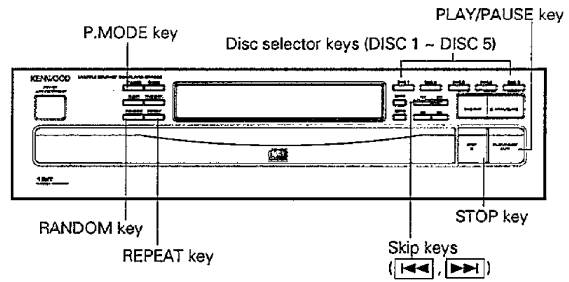

■ Playing tracks in a random order

1 Ensure that the CD player is in the TRACK mode.

- If the [PGM] indicator is lighted, press the [P.MODE] key.

2 Press the RANDOM key.



During random track selection.

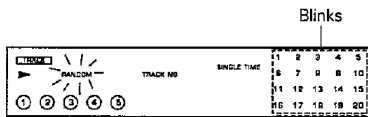

During random selection play.

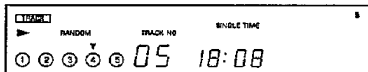

- Tracks from all the disc(s) in the tray will be played randomly.
- When the first track has been played, another track is selected at random again, and played.

To select another track during random play

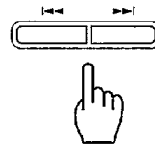

To cancel random play

Press either one of these keys.

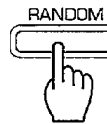

- Normal play starts from the track being played.



- Playback stop.

Note:

The same track on the same CD will not play twice over continuously, however, it may happen that the same track is repeated later in play.

Editing

This function is for editing when you are recording the contents of a CD onto a tape. It is to ensure that the final track on each side of the tape is fully recorded and that the possible recording time on the tape will be fully used.

The two sides of two discs can be edited by using EDIT-1 and EDIT-2 keys respectively. This function is useful when continuous recording using two cassettes.

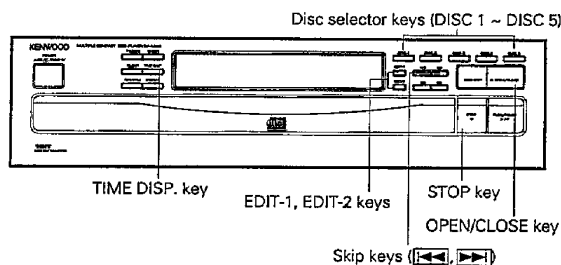

■ To edit

1 Press the STOP key.

- Ensure that the CD player is in the TRACK mode.

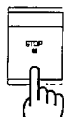

2 Press the EDIT-1 key.



- The EDIT-2 key cannot be pressed until after the first disc has been edited using the EDIT-1 key.

3 Select the disc to be edited (one disc only).



- The edit function cannot be used for two or more discs.

"C -" is displayed after a few seconds.

4 Input the recording time of the tape.

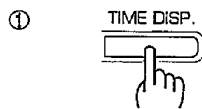

After the "C -" is displayed, enter the tape length.

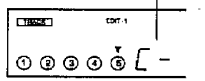

- By pressing the TIME DISP. key the set time-length intervals will change in this order: 46→54→60→90.
- By using the skip key or , interval lengths can be adjusted in units of one minute (to a maximum of 99 minutes).
 : increase by one minute.
 : decrease by one minute.

② Press the EDIT-1 key once again.



- When the interval length has been set using the numeric keys on the remote control of the amplifier/receiver, the EDIT-1 key does not have to be pressed after the interval has been set.

The CD contents are edited as follows.

- (1) The input tape recording time is divided by two, and tracks that can be accommodated in file A (which refers to tracks on tape side A) are selected in order of their track Nos.

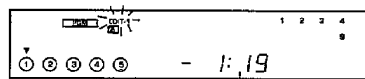

Remaining time in file A

- (2) In a few seconds, the time left on tape side A is displayed, then file B (tracks on tape side B) is edited in the same manner.



Remaining time in file B

- If the STOP key or OPEN/CLOSE key is pressed during editing, editing will be suspended and the function terminated.

Completion of editing

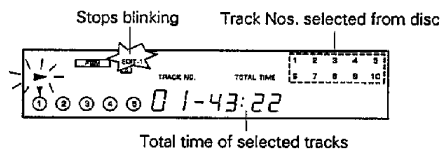

Total time of selected tracks

To edit the second disc

Press the EDIT-2 key as in step number 2, and repeat steps 3 and 4.



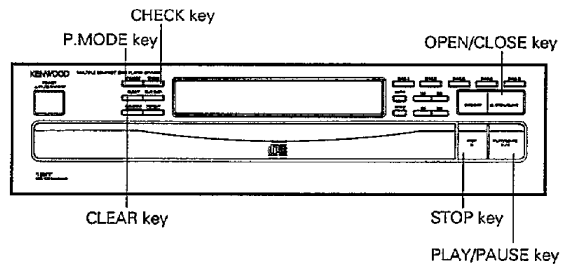

■ To check the edited contents

Press the CHECK key.

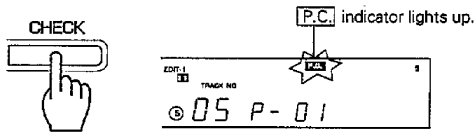

- Every time the [CHECK] key is pressed, the track Nos. are displayed in the edited order.
- This function can be used only after pressing the [STOP] key.

■ To record an edited program

The CCRS recording function may be used by connecting the CD player to any KENWOOD cassette deck with an "XSD" mark, using a system control cord. If connected to a cassette deck that is able to relay recording, material edited using the EDIT-1 and EDIT-2 keys can be continuously recorded. For details please refer to "Recording of CD playback" section in your cassette deck instruction manual.

- The CCRS double-speed recording function may be used when decks that are made to handle twice normal speed dubbing are used.
- When connected to a single deck or one way deck, this function may prove to be partially unusable.

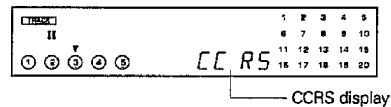

■ To play an edited program



- The play starts in order from the first track in file A and then pauses at the beginning of file B.
- To listen to file B, press the [▶/II] key again.

■ To clear the edited contents

Press either of these keys.



- Edited material will be completely cleared by just pressing the [OPEN/CLOSE] key.

Notes:

1. While you can edit with a different time setting to that of the tape you are using, part of the tape may be left with nothing recorded on it, or the last track on side A or side B may be cut short.
2. Up to a maximum of 20 tracks can be edited using this function.
3. The EDIT function may not operate properly for discs having only one track or having tracks of long duration such as classical music.

Timer operations

The unit has the timer stand-by function.

With this function and commercially-available audio timer, playback can be started at the desired time.

1 Connect the power cord.

- Connect each unit's power cord to the SWITCHED outlet of the timer
- Refer to the instruction manual of the timer.

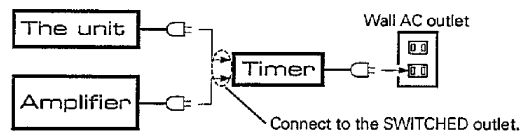

2 Turn on the amplifier and the unit.

3 Insert a disc and set the starting time of the timer.

- Set the timer while the unit and the amplifier are ON.
- Playback starts at the set time.
- Be careful of the volume setting of the amplifier. (The loud sound may damage the speakers.)

Note:

When operating the unit other than CD player using an audio timer, be sure to remove the disc from the CD player.

Maintenance

■ Beware of condensation

When water vapor comes into contact with the surface of cold material, water drops are produced. If condensation occurs, correct operation may not be possible, or the unit may not function correctly. This is not a malfunction, however, and the unit should be dried. (To do this, turn the POWER switch ON and leave the unit as it is for several hours.)

Be specially careful in the following conditions.

- When the unit is brought from a cold place to a warm place, and there is a large temperature difference.
- When a heater starts operating.
- When the unit is brought from an air - conditioned place to a place of high temperature with high humidity.
- When there is a large difference between the internal temperature of the unit and ambient temperature, or in conditions where condensation occurs easily.

■ Note related to transportation and movement

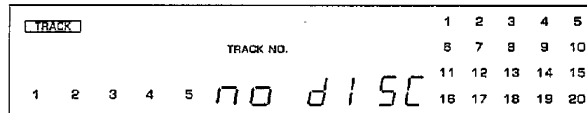

Before transporting or moving this unit, carry out the following operations.

1. Turn the power ON but do not load a disc.
2. Wait a few seconds and verify that the display shown appears. Wait further a few seconds.
3. Turn the power OFF.



In case of difficulty

When appears to be a malfunction may not always be serious. If your unit should not perform as expected, consult the table below to see if the problem can be corrected before seeking help from your dealer or service representative.

Symptom	Cause	Remedy
No power is applied with the POWER switch ON.	<ul style="list-style-type: none"> ● Power plug is loosely connected. ● With the power plug connected to the switched AC outlet of an amplifier, the power of the amplifier is turned off. 	<ul style="list-style-type: none"> ● Insert the power plug firmly to the AC outlet. ● Turn the amplifier's power ON.
Disc is loaded, player does not play.	<ul style="list-style-type: none"> ● Disc is loaded upside down. ● Disc is loose. ● Disc is dirty. ● Disc is cracked. ● Condensation occurred on the optical lens unit. 	<ul style="list-style-type: none"> ● Load the disc again with its label side up. ● Insert disc properly. ● Wipe off the dust on the surface of the disc referring to "Disc handling precautions". ● Replace the disc with a new one. ● Leave the player for about 1 hour so that the condensation is removed.
No sound.	<ul style="list-style-type: none"> ● Disc is not loaded. ● Play mode is not entered (The play/pause indicator is not lit). ● Disc is too dirty. ● Disc is cracked. ● The connection cords are inserted loosely. 	<ul style="list-style-type: none"> ● Load a disc and press the PLAY/PAUSE key . ● Press the PLAY/PAUSE key . ● Wipe off the dust on the disc surface referring to "Disc handling precautions". ● Replace the disc with a new one. ● Connect all connection cords firmly.
Music is interrupted. (Sound is skipped.)	<ul style="list-style-type: none"> ● Disc is too dirty. ● Disc is cracked. ● Oscillation is applied to this unit. 	<ul style="list-style-type: none"> ● Wipe off the dust on the disc surface referring to "Disc handling precautions". ● Replace the disc with a new one. ● Try selecting a place where no strong vibrations occur by changing the installation place, etc.
Disc begins to play when power is switched ON.	<ul style="list-style-type: none"> ● The CD player will automatically play when a disc has been inserted and power is switched ON. 	<ul style="list-style-type: none"> ● To avoid disc playing automatically, remove disc before switching off power.

Notes:

1. This system is microprocessor-controlled, so malfunction may occur due to external noise or interference noise. In such a case, unplug the power cord, plug it and turn power on again.
2. Do not use contact cleaners because it could cause a malfunction. Be specially careful against contact cleaners containing oil, for they may deform the plastic components.

Specifications

Format

System Compact disc digital audio system
Laser Semiconductor laser
Playing rotation 200 rpm - 500 rpm (CLV)

D/A convertors

D/A conversion 1 Bit
Oversampling 8 fs

Audio

Frequency response 4 Hz ~ 20 kHz, ± 1.0 dB
Signal to noise ratio more than 96 dB
Dynamic range more than 94 dB
Total harmonic distortion less than 0.008 % at 1 kHz
Wow flutter unmeasurable limit
Output level/impedance 2.0 V/3.3 k Ω

General

Power consumption 15 W
Dimensions W : 440 mm (17-5/16")
H : 120 mm (4-3/4")
D : 390 mm (15-3/8")
Weight (Net) 5.4 kg (11.9 lb)

Note:

KENWOOD follows a policy of continuous advancements in development. For this reason specifications may be changed without notice.

For CANADA DOC REGULATION

"This digital apparatus does not exceed the CLASS B limits for radio noise emissions from digital apparatus as set out in the radio interference regulations of the Canadian Department of Communications."

For the U.S.A. FCC WARNING

This equipment may generate or use radio frequency energy. Changes or modifications to this equipment may cause harmful interference unless the modifications are expressly approved in the instruction manual. The user could lose the authority to operate this equipment if an unauthorized change or modification is made.

NOTE

This equipment has been tested and found to comply with the limits for a Class B digital device, pursuant to Part 15 of the FCC Rules. These limits are designed to provide reasonable protection against harmful interference in a residential installation. This equipment may cause harmful interference to radio communications, if it is not installed and used in accordance with the instructions. However, there is no guarantee that interference will not occur in a particular installation. If this equipment does cause harmful interference to radio or television reception, which can be determined by turning the equipment off and on, the user is encouraged to try to correct the interference by one or more of the following measures:

- Reorient or relocate the receiving antenna.
- Increase the separation between the equipment and receiver.
- Connect the equipment into an outlet on a circuit different from that to which the receiver is connected.
- Consult the dealer or an experienced radio/TV technician for help.

KENWOOD